

# Lovibond®

## PFXi-Series

OPERATOR'S INSTRUCTION MANUAL



The Tintometer Limited, Solar Way, Solstice Park, Amesbury, Wilts, SP4 7SZ  
Telephone: +44 1980 664800 Email: [sales@tintometer.com](mailto:sales@tintometer.com)

Contents	
Lovibond®	1
Disposal of Waste Electrical and Electronic Equipment	4
Warning	4
Introduction	5
Using the manual	5
Caution and safety signs	5
User responsibility	5
Instrument Specification	6
Description	6
Colour scales	6
Unpacking	9
Installation	10
The Instrument	11
Rear View	11
Front View	11
The Keypad	12
Switching on the Instrument	13
Hardware Setup	13
Regional Settings	13
Language Setup	13
Setting the Date	14
Setting the Time	14
Setting the Date Format	15
Setting the Decimal Separator	15
Network Settings	16
Setting the IP Allocation	16
For Static IP Allocation	16
Setting the Subnet Mask	17
Setting the Default Gateway	18
General Settings	18
Setting the Event Log	19
Setting the Beeper	19
Setting the Display Sleep Time	19
Measurement Options	20
Measurement Settings	20
ID Settings	20
CIE Settings	20
Changing the Observer	21
Changing the Illuminant	21
Path Length	22
Selecting Cell Path Length from the List	22
User Defined Path Length	22
User Length Units	23
Sample Properties	23
Dilution Factor	23
Entering the default Dilution factor	23
Brix Value	24
Measurement Averaging	25
Switch Measurement Averaging On/Off	25
Setting the Number of Measurements to Average	25
Selecting the Averaging Method	25
Setting the Time Interval for Automatic Averaging	26
Measurement Logging	27
Switching Logging On/Off	27
Setting the Heater (only available on heated versions)	27
Switching the Heater On/Off	27
Temperature	27
Setting the Required Temperature	28
Selecting Colour Scales	29

Unlocking a Colour Scale .....	29
Performing a Baseline Measurement .....	30
Sample Preparation .....	30
Taking a Measurement .....	32
Displaying Results .....	33
Spectral Information .....	33
CIE Color Scales .....	34
Other Colour Scales .....	34
Printing Results .....	35
Colour Difference Mode .....	35
Converting a Sample to a Standard .....	36
Understanding Off Hue .....	37
Database Functions .....	39
Store the Current Measurement .....	39
Retrieve a Measurement .....	40
Edit a Stored Measurement .....	40
Remote Calibration .....	42
Maintenance .....	44
The Lamp .....	44
After the lamp has been changed, .....	44
Sample Chamber .....	45
Lovibond® Glass Cells .....	45
Certified colour reference materials .....	46
Factors Influencing Inter-Instrument Differences in Lovibond® Colour Measurements .....	47
Appendix 1 .....	49
The procedure for upgrading the PFXi firmware .....	49
Appendix 2 .....	52
Registering your Instrument .....	52



## Disposal of Waste Electrical and Electronic Equipment

This symbol on the product or on its packaging indicates that this product shall not be treated as general waste. Instead it shall be handed over to an applicable recycling scheme or the original manufacturer for the recycling of electrical and electronic waste.

By ensuring that this product is disposed of correctly, you will help prevent potential negative consequences for the environment and human health, which could otherwise be caused by inappropriate waste handling of this product.

The recycling of materials will help conserve natural resources. For more information about recycling this product, please contact your waste disposal service, the manufacturer or the company from where you purchased this product.

## Warning

A moulded plug is fitted to the mains lead for your safety and convenience. The plug should only be changed by an approved service centre.

## Introduction

### Using the manual

The following typefaces and icons are used in this manual:

[ ] Characters between bold square brackets indicate a key on the keypad.

Example:

**[ZERO]** Baseline measurement key



Up key on Keypad

***Italics*** A typeface in bold Italics indicates characters as shown on the display.

Examples:

Select menu item

Press any key to continue

### Caution and safety signs



Caution

Refer to manual



Warning

Hot surface

### User responsibility

The responsible body should be made aware that, if the instrument is used in any way not specified by the manufacturer, the protection provided by the equipment might be impaired.

Technical Specification	PFXi 195	PFXi 880/950/995
Measuring principle	9 interference filters	16 interference filters
Spectral response	420 – 710 nm	
Bandwidth	10 nm	
Repeatability	On measurements of de-ionised water	
Chromaticity	+/- 0.0004	+/- 0.0002
Delta E	0.4	0.2
Measurement time	Less than 20 seconds	
Baseline calibration	Single key press; fully automated	
Light source	5 Volt, 10 Watt Tungsten Halogen	
Illuminants	CIE Illuminants A, B, C, D65	
Observer	2°, 10°	
Path length	0.1 – 50 mm	0.1 – 153 mm (.004" – 6")
Interfaces	USB, LAN, RS232	
Data storage	100,000+ Measurements	
Input voltage	Universal (90 – 240 Vac), via external power supply	
Compliance	CE, RoHs, WEEE	
Display	240 x 128, LED backlit graphic display (white on blue)	
Keypad	23 key tactile membrane keypad, washable polyester with optional audible feedback	
Languages	English, French, German and Spanish	
Heater unit	N/A	Optional, Ambient to 95°C
Instrument housing	Fabricated steel with tough, textured paint finish	
Dimensions	Width 435 mm Depth 195 mm Height 170mm	Width 515 mm Depth 195 mm Height 170mm
Weight	6.8 kg	7.7 kg

## Instrument Specification

### Description

Lovibond® PFXi instruments are high-precision, spectrophotometric colorimeters which are designed for objective colour measurement of clear liquids or transparent solids. They are easy to use, automatic instruments which overcome the subjectivity of visual methods. The menu system guides operators through the selection of operating parameters. Thereafter, measurements are initiated by just a single key press and take less than 20 seconds to complete. PFXi instruments are rugged colorimeters with fabricated steel housing which are designed to function as a QC instrument within the laboratory or on 24-hour operation in a process control environment.

Lovibond® PFXi instruments operate as stand-alone colorimeters containing a standardised light source and collimator, sample chamber, light detector, monochromator and processor board.

### Colour scales

Lovibond® PFXi instruments are designed to meet the colour analysis requirements of light transmitting samples such as liquid chemicals, fuels, beers and waters. The PFXi series provides colour data according to a full range of established industry scales. Measurements can also be displayed in terms of spectral data and CIE values. PFXi instruments also allow users to obtain a closest match to stored references or to build up a customised scale from a series of reference samples. The user can easily customise the PFXi instrument to display only those scales of interest.

Lovibond® PFXi Series Operator's Instruction Manual V1.11

Key: ● Standard on Instrument. ○ Optional Upgrade. \* Can be ordered with a factory fitted heater or retrofitted

Colour Scale	References	Scope	Range	Instrument Type																			
				19511	19512	19513	19514	19515	19516	19517	19518	19519	880L*	880AT*	880P*	880S8	880IP17*	880CIE	950*	950P*	995*	995P*	
Acid Wash	ASTM D848-03	Indication of impurities which if sulfonated would cause the material to be discolored	1 – 14	○	○	○	○	○	○	○	○	○	○	○	○	○	○	○	○	○	○	○	○
ADMI (full spectrum and tristimulus filter)	American Standard Methods 2120 E	Coloured waters and tinted liquids	0 - 500	○	○	○	○	○	○	○	○	○	●	○	○	○	○	○	○	○	○	○	○
AOCS-Tintometer	AOCS Cc 13b-45 AOCS Cc 8d-55 AOCS Cc 13j-97	Special red and yellow version of the Lovibond® RYBN scale used for oils, fats and derivatives	0 - 20 Red, 0 - 70 Yellow	■										○	●	○	○	○	○	○	○	○	○
ASBC Color	ASBC	American standard for colour grading of beers; derived from EBC Colour		○	○	○	○	○	○	○	○	○	○	○	○	○	○	○	○	○	○	○	○
ASTM Color	ASTM D 1500, ASTM D 6045, ISO 2049	A wide range of petroleum products including lubricating oils, heating oils and diesel fuel oils	0.5 - 8 units	○	○	○	○	○	○	○	○	○	○	○	○	○	○	○	○	○	○	○	○
beta Carotene	BS684 Section 2.20	Direct measurement of content in parts per million	0 - 1000 ppm	■										○	○	○	○	○	○	○	○	○	○
Chinese Pharmacopoeia (CP)		Pharmaceutical solutions	YG, Y, OY, OR, BR	○	○	○	○	○	○	○	○	○	○	○	○	○	○	○	○	○	○	○	○
Chlorophyll A & B	AOCS Cc 13d-55	Direct measurement of content in parts per million	0 - 100 ppm	■										○	○	○	○	○	○	○	○	○	○
EBC Colour	Analytica	Beers, malts and caramels and similarly coloured liquids. Based either on absorption at 430 nm or CIE x y chromaticity co-ordinates	2 - 27 units	○	○	○	○	○	○	○	○	○	○	○	○	○	○	○	○	○	○	○	○
European Pharmacopoeia (EP)	European Pharmacopoeia 2.2.2	Pharmaceutical solutions	R, Y, B, BY, GY	○	○	○	○	○	○	○	○	○	○	○	○	○	○	○	○	○	○	○	○
FAC Colour	AOCS Cc 13a-43	Approved by the Fats Analysis Committee of the American Oil Chemists Society for grading dark coloured oils, fats and tallows	1 - 45 (odd numbers)	○	○	○	○	○	○	○	○	○	○	○	○	○	○	○	○	○	○	○	○
Gardner Color	ASTM D 1544, ASTM D 6166, AOCS Td 1a-64	Chemicals and oils ranging from pale yellow to red, such as resins, varnishes, drying oils, lecithins and fatty acids	0 - 18 units	○	○	○	○	○	○	○	○	○	○	○	○	○	○	○	○	○	○	○	○
Hess-Ives Color Units		Chemicals and surfactant liquids		○	○	○	○	○	○	○	○	○	○	○	○	○	○	○	○	○	○	○	○
Honey Colour (Pfund Equivalents)		Commercial honeys, ranging from pale yellow through amber to deep red	0 – 115 mm	○	○	○	○	○	○	○	○	○	○	○	○	○	○	○	○	○	○	○	○
ICUMSA Colour, 420 nm, 560 nm, 710 nm	ICUMSA GS1-7, ICUMSA GS2/3-9	Sugar solutions & syrups		○	○	○	○	○	○	○	○	○	○	○	○	○	○	○	○	○	○	○	○
Iodine Colour	DIN 6162	Solvents, plasticisers, resins, oils and fatty acids ranging from yellow to brown	1 - 500 units	○	○	○	○	○	○	○	○	○	○	○	○	○	○	○	○	○	○	○	○
IP Units	IP 17 Method B	Light coloured products such as refined undyed motor fuel, white spirit or kerosene	Water White (0.25) to Standard White (4.0)	■										○	○	○	○	○	○	○	○	○	○
Klett Color (blue filter KS-42)	AOCS Dd 5-92	Detergents and surfactants	0 - 1000 units	○	○	○	○	○	○	○	○	○	○	○	○	○	○	○	○	○	○	○	○





## Unpacking

The PFXi series is supplied with:

PFXi series instrument (PFXi-195, PFXi-880, PFXi-950 or PFXi-995)

External power supply

Set of 3 power leads (UK, European and United States)

Quick start guide

CD ROM (Containing Windows control software and manuals)

Accessory Box: Containing 1 of each item specified in the table below for the instrument type.

Description	195\1	195\2	195\3	195\4	195\5	195\6	195\7	195\8	195\9	880\L	880\L + Heater	880\VAT	880\VAT + Heater	880\IP	880\IP + Heater	880\S	880\S + Heater	880\IP17	880\IP17 + Heater	880\CIE	880\CIE + Heater	950	950 + Heater	950\IP	950\IP + Heater	995	995 + Heater	995\IP	995\IP + Heater
5 Volt Halogen Lamp	•	•	•	•	•	•	•	•	•	•	•	•	•	•	•	•	•	•	•	•	•	•	•	•	•	•	•	•	•
Conformance Filter	•	•	•	•	•	•	•	•	•	•	•	•	•	•	•	•	•	•	•	•	•	•	•	•	•	•	•	•	•
W600/OG/10 Cell	•		•	•		•	•	•	•											•						•		•	
W600/B/10 Cell																					•		•					•	
W600/OG/25 Cell				•																									
W600/OG/33 Cell		•												•										•				•	
W600/B/33 Cell															•										•				•
W600/OG/40 Cell					•	•																							
W600/OG/50 Cell	•	•			•	•	•	•																					
W600/OG/100 Cell														•		•								•		•		•	
W600/B/100 Cell															•		•							•		•		•	
W600/OG/1" Cell										•		•										•				•		•	
W600/B/1" Cell											•		•									•		•			•		•
W600/OG/5¼" Cell										•		•										•				•			
W600/B/5¼" Cell											•		•										•				•		
W600/OG/6" Cell																												•	
W600/B/6" Cell																													•

Genuine Lovibond® Cells are supplied with each instrument. Only use genuine Lovibond® cells to ensure repeatability in test results. Other cells may not be manufactured to the same rigorous quality standards.

Replacement Lovibond® cells may be purchased by quoting the description (e.g W600/B/10).

The cells are coded as follows:

W600/ = Type of cell – size/height etc

OG/ = Optical glass

B/ Borosilicate glass for high temperature samples

10 = 10 mm path length

50 = 50 mm path length

The Lovibond® PFXi-195 weighs 6.8 kg and the PFXi-880/950/995 weighs 7.8 kg. One person may easily lift it by placing their hands at either end of the instrument and lifting. Carefully remove the Lovibond® PFXi from its packing case. Remove the desiccated silica gel pack from the sample chamber. The power supply, mains lead and accessories are all included in the packaging.

### Installation

Place the instrument on a bench near a mains voltage supply which is free from excessive voltage fluctuations. The external power supply is auto voltage sensing, so no setting up is required for local voltages.



Do not operate the instrument in an atmosphere containing explosive gases.



Plug in the mains lead and switch on. The blue backlight of the display will indicate that the instrument is on.

If the instrument has been in a cold environment prior to setting up, allow the instrument to warm up to room temperature and ensure that all condensation has dissipated before switching on.

Always ensure that there is sufficient free space around the instrument to maintain a constant flow of air.

## The Instrument

### Rear View



1 USB port	4 24 Volt power input
2 RS232 port	5 ON/OFF switch
3 Local area network (RJ45) Port	

### Front View

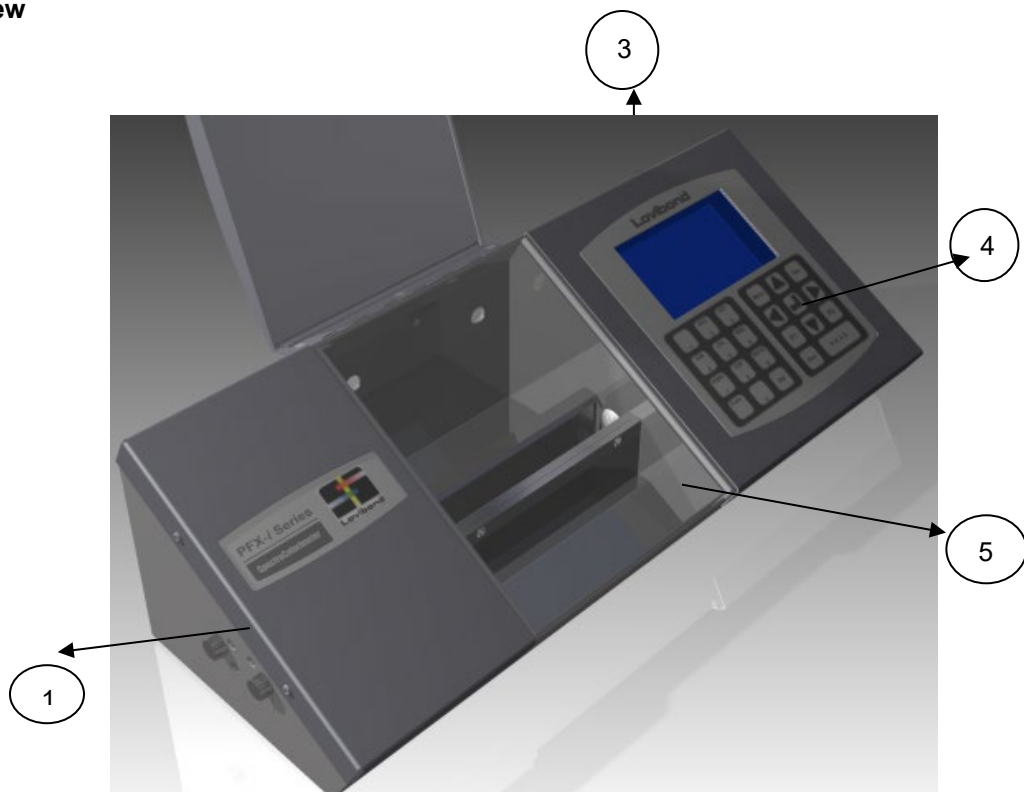

#### Key:

1 Lamp access panel	4 Keypad
3 LCD display	5 Sample chamber

## The Keypad

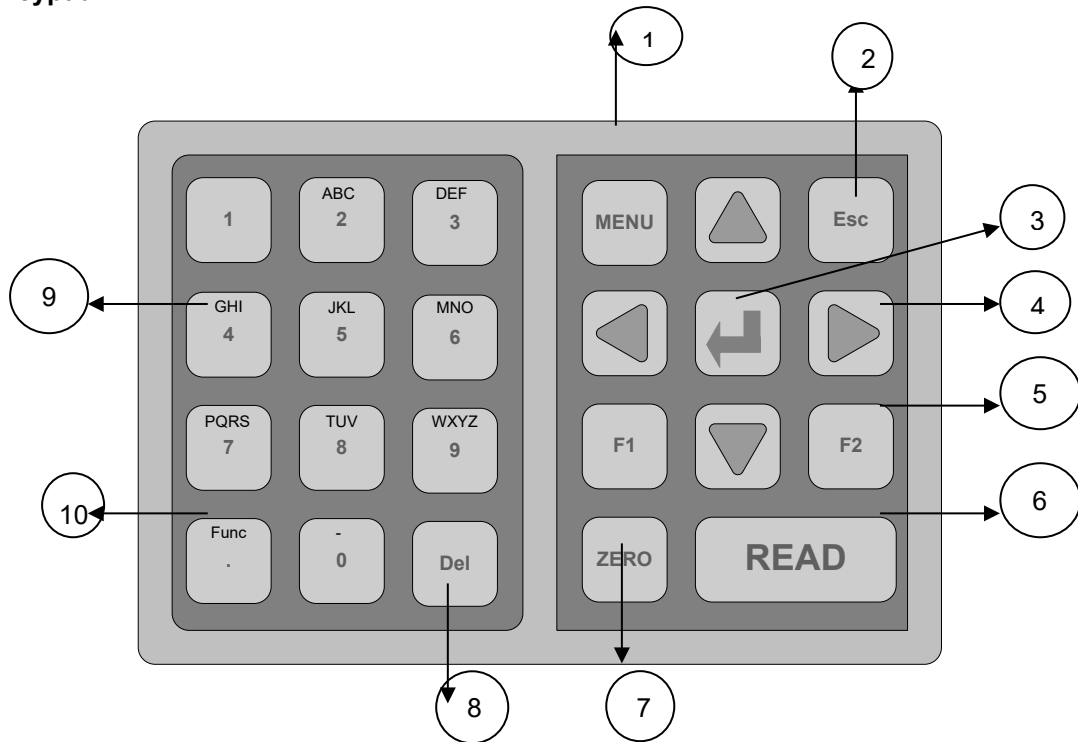

**Key:**

1) Menu: Selects menu system or returns to the main menu	6) Read: Initiates the measurement of a sample
2) Esc: Exits a menu and commits any changes made	7) Zero: Initiates a baseline measurement
3) Enter: Used to select items from the menu	8) Del: Deletes characters during user input
4) Cursor: The cursor keys are used to move the menu selection bar up and down and to scroll sideways through selections	9) Alpha numeric keys used for user input
5) Special purpose function keys	10) Func: Special function key

## Switching on the Instrument



When the instrument is powered on the display shows the model number, serial number and the version of firmware installed.

## Hardware Setup

### Regional Settings



Press **MENU**

Press **▲** or **▼** to move the Highlight bar to **“Hardware Setup”**.

Press **↵** to select.



Press **▲** or **▼** to move the Highlight bar to **“Regional Settings”**.

Press **↵** to select.

### Language Setup

The PFXi series instruments contain the following languages: English, French, German, Spanish, Italian, Portuguese, Chinese, Russian and Japanese. The instrument can be changed to any of these languages at any time. The displayed language will automatically change to the chosen language on leaving this menu screen.

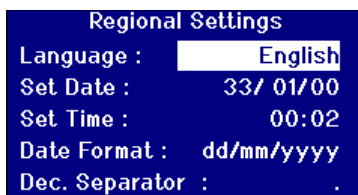

Press **▲** or **▼** to move the Highlight bar to **“Language”**.

Press **▶** or **◀** to scroll through the list of options.

Press **Esc** to leave the menu and commit the change or

Press **▲** or **▼** to move to the next menu item.

When in the Main Menu, the language can also be changed by pressing **Funct** and one of the following codes.

- 221 English
- 222 French
- 223 German
- 224 Spanish
- 225 Portuguese
- 226 Italian
- 227 Russian
- 228 Chinese
- 229 Japanese

## Setting the Date

The PFXi series has a real time clock that is used to keep track of time. The date set in the clock is used for storage of results and is printed along with the result. The clock automatically deals with leap years.

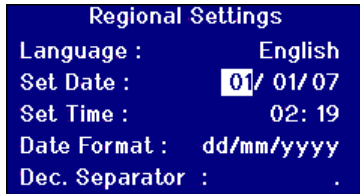

Press or to move the Highlight bar to **“Set Date”**. The first item highlighted is the day of the month.

**Note:** The format used for setting the date is always Day/Month/Year.

Press to change the value.

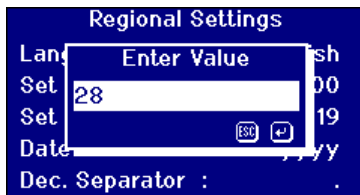

Use the numeric keys to enter the value required. Press to delete the last character entered if a mistake is made.

Press to exit without changing the value or press to accept the value and return to the previous screen.

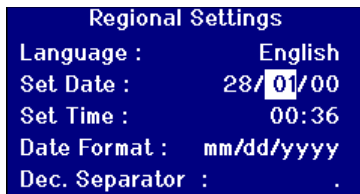

If the value was changed the display will now reflect the change made.

Press or to move between items.

## Setting the Time

The instrument provides a 24 hour clock; the format for the time is in the 24 hour clock style.

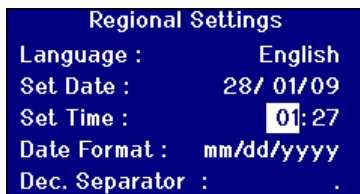

Press or to move the Highlight bar to **“Set Time”**. The first item highlighted is the Hour of the day. The hours are in the 24 hour clock format.

Press to change the value.

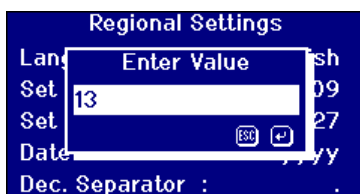

Use the numeric keys to enter the value required. Press to delete the last character entered if a mistake is made.

Press to exit without changing the value or press to accept the value and return to the previous screen.

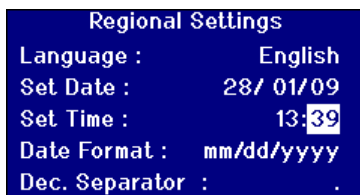

Press or to move the Highlight to the next item.

### Setting the Date Format

The format for the date can be set as either day/month/year or month/day/year. This format is used when sending data to a computer or printer and with stored results. The date displayed on the instrument is always in the day/month/year format.

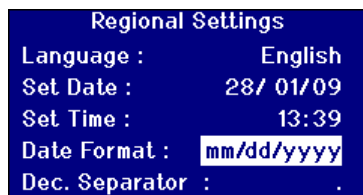

Press or to move the Highlight bar to **“Date Format”**.

Press or to scroll through the list of options.

The options are mm/dd/yyyy or dd/mm/yyyy.

Press to leave the menu and commit the change or

Press or to move to the next menu item.

### Setting the Decimal Separator

The format for the decimal separator can be either “.” or “,”. This option is only used to format data sent to a printer or computer. The option set should match the regional settings set on a host computer. Within the instrument a “.” is always used as the decimal separator.

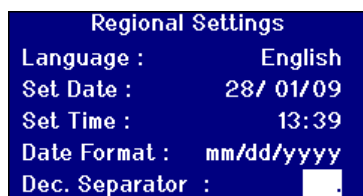

Press or to move the Highlight bar to **“Dec. Separator”**.

Press or to scroll through the list of options.

The options are “.” or “,”.

This option is only used to format data sent to a printer or computer. The option set should match the regional settings set on a host computer. Within the instrument a “.” is always used as the decimal separator.

Press to leave the menu and commit the change or

Press or to move to the next menu item.

## Network Settings



Press **MENU**

Press **▲** or **▼** to move the Highlight bar to **“Hardware Setup”**.

Press **▾** to select.



Press **▲** or **▼** to move the Highlight bar to **“Network Settings”**.

Press **▾** to select.

### Setting the IP Allocation.

DHCP (Dynamic Host Configuration Protocol): The instrument is allocated an IP address from a DHCP server. If this option is chosen, there is no need to fill in any of the other network settings values.

Static: The network administrator will provide an IP address for the instrument that should be entered.

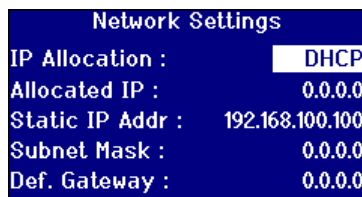

Press **▲** or **▼** to move the Highlight bar to **“IP Allocation”**.

Press **▶** or **◀** to scroll through the list of options.

The options are “DHCP” or “Static”.

### For Static IP Allocation

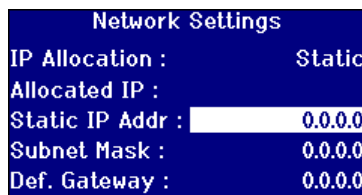

Press **▲** or **▼** to move the Highlight bar to **“IP Address”**.

Press **▾** to change the value.

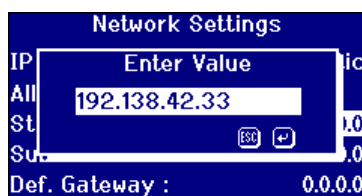

Use the numeric keys and the **.** to enter the value required. Press **Del** to delete the last character entered if a mistake is made.

The format for an IP Address is xxx.xxx.xxx.xxx where the maximum value for xxx is 255.

Press **Esc** to exit without changing the value or Press **▾** to accept the value and return to the previous screen.





If an error is made in entering the IP Address, the following message screen will be displayed. Press to exit the screen and re-enter the value required.



Press or to move the highlight to the next item.

### Setting the Subnet Mask



Press or to move the highlight bar to “**Subnet Mask**”.

Press to change the value.

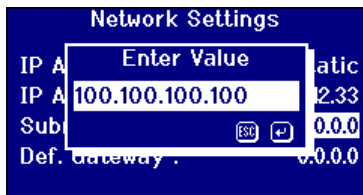

Use the numeric keys and the to enter the value required. Press to delete the last character entered if a mistake is made.

The format for an IP Address is xxx.xxx.xxx.xxx where the maximum value for xxx is 255. Typically the Subnet mask has a value of 255.255.255.0

Press to exit without changing the value or Press to accept the value and return to the previous screen.

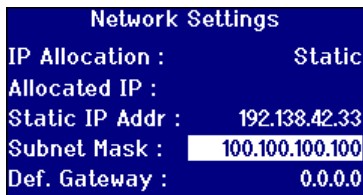

Press or to move the highlight to the next item.

## Setting the Default Gateway

A default gateway is a node (a router) on a computer network that serves as an access point to another network. The PFXi instruments use this to connect to the remote calibration server or for the remote diagnostic utility.



Press **↑** or **↓** to move the Highlight bar to **“Def. Gateway”**.

Press **↵** to change the value.

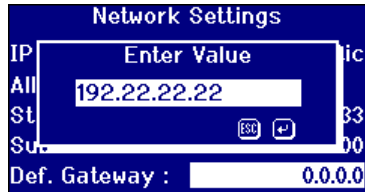

Use the numeric keys and the **.** to enter the value required. Press **Del** to delete the last character entered if a mistake is made.

The format for an IP Address is xxx.xxx.xxx.xxx where the maximum value for xxx is 255.

**Note:** See your network administrator for this value.

Press **Esc** to exit without changing the value or Press **↵** to accept the value and return to the previous screen.

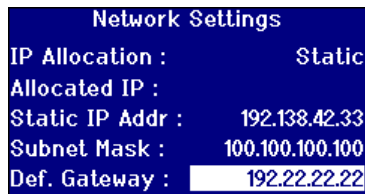

Press **↑** or **↓** to move the Highlight to the next item.

## General Settings



Press **MENU**

Press **↑** or **↓** to move the Highlight bar to **“Hardware Setup”**.

Press **↵** to select.



Press **↑** or **↓** to move the Highlight bar to **“General Settings”**.

Press **↵** to select.

### Setting the Event Log

The Event Log records any changes made to the settings of the instrument. The data is sent out to the port specified in the "Log File Port" in "Measurement Logging".

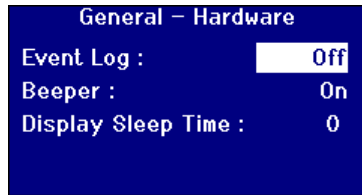

Press or to move the Highlight bar to **"Event Log"**.

Press or to scroll through the list of options.

The options are "On" or "Off".

### Setting the Beeper

Each time a key is pressed an audible beep will sound if this option is switched on or it will remain silent with this option switched off.

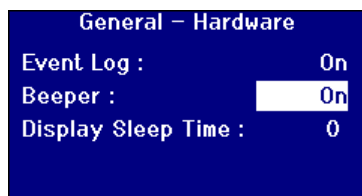

Press or to move the Highlight bar to **"Beeper"**.

Press or to scroll through the list of options.

The options are "On" or "Off".

### Setting the Display Sleep Time

The display backlight can be set to switch off after a set interval if there has been no activity. This reduces the power that the instrument uses when in standby. This time interval is measured in minutes.

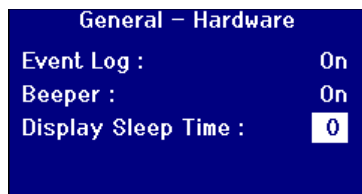

Press or to move the Highlight bar to **"Display Sleep Time"**.

Press to change the value.

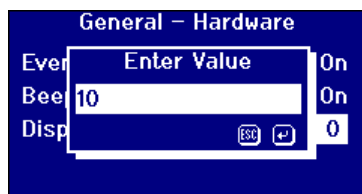

Use the numeric keys and the to enter the value required. Press to delete the last character entered if a mistake is made.

Note: The time is in minutes.

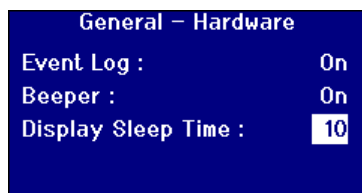

Press or to move the Highlight to the next item.

## Measurement Options

### Measurement Settings



Press **MENU**

Press or to move the Highlight bar to **“Measurement Options”**.

Press to select.

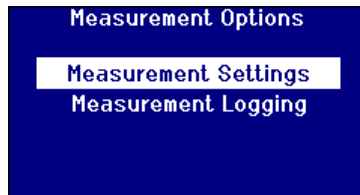

Press or to move the Highlight bar to **“Measurement Settings”**.

Press to select.

### ID Settings

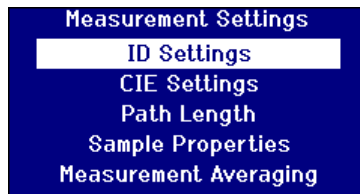

Press or to move the Highlight bar to **“ID Settings”**.

Press to select.

### User ID Settings

When the User ID is enabled, a box will pop up when a measurement is made requesting the User ID. With the User ID set to “Optional” the user is able to press to enter an empty value or enter up to a 4 character string. When the User ID is set to “Required” the user must enter at least one character to proceed.

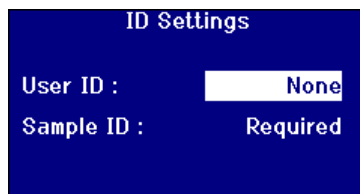

Press or to move the Highlight bar to **“User ID”**.

Press or to scroll through the list of options.

The options are “None”, “Optional” or “Required”.

### Sample ID Settings

When the Sample ID is enabled, a box will pop up when a measurement is made requesting the Sample ID. With the Sample ID set to “Optional” the user is able to press to enter an empty value or enter up to a 10 character string. When the sample ID is set to “Required” the user must enter at least one character to proceed.

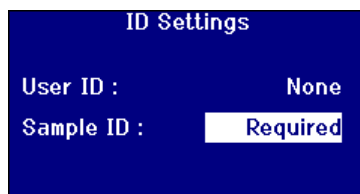

Press or to move the Highlight bar to **“User ID”**.



Press or to scroll through the list of options.

The options are “None”, “Optional” or “Required”.

### CIE Settings

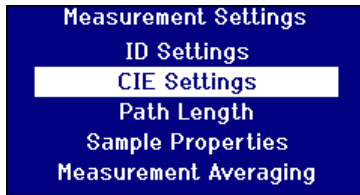
When measuring using one of the CIE colour spaces, the user needs to set the correct observer and illuminant setting. Changes to these values only affect the CIE scales. They do not have an effect on the other colour scales.





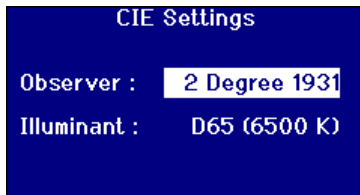

Press  or  to move the highlight bar to “**CIE Settings**”.

Press  to select.

### Changing the Observer





Press  or  to move the highlight bar to “**Observer**”.

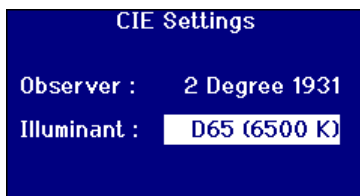

Press  or  to scroll through the list of options.

The options are “2 Degree 1931” or “10 Degree 1964”.

### Changing the Illuminant



Press  or  to move the highlight bar to “**Illuminant**”.

Press  or  to scroll through the list of options.

The options are CIE Illuminants A, B, C and D65.

## Path Length

Certain colour scales and parameters use the path length of the sample cell within their calculation, such as Chlorophyll, beta carotene, EBC and Icumsa. The user should always set the path length to that of the sample cell being used. This is also important when printing or storing results as the path length is saved along with the measurement data.

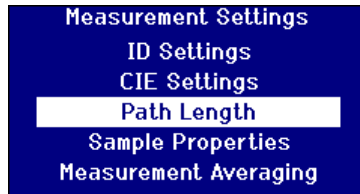

Press or to move the highlight bar to **“Path Length”**.

Press to select.

### Selecting Cell Path Length from the List

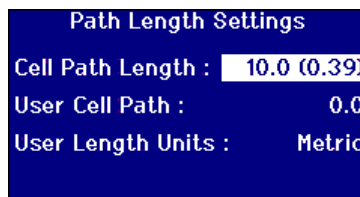

Press or to move the highlight bar to **“Cell Path Length”**.

Press or to scroll through the list of path lengths.

### User Defined Path Length

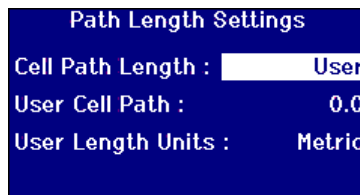

Press or to scroll through the list of options until **“User”** appears.

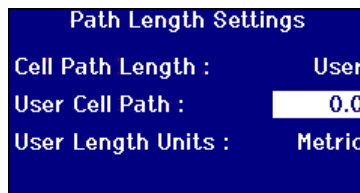

Press or to move the highlight bar to **“Enter Cell Path”**.

Press to change the value.

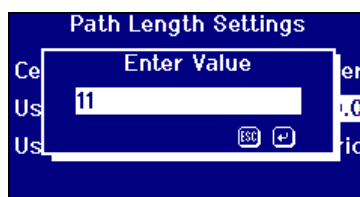

Use the numeric keys and the to enter the value required. Press to delete the last character entered if a mistake is made.

Press to exit without changing the value or Press to accept the value and return to the previous screen.

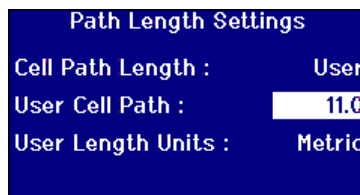

Press or to move the highlight to the next item.

## User Length Units

This setting sets the measurement system for the User entered cell path length.

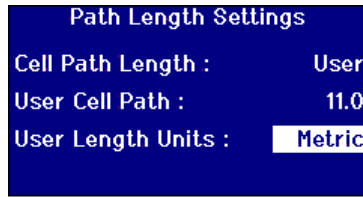

Press or to move the highlight bar to **“User Length Units”**.

Press or to scroll through the list of options.

Options are Metric (mm) or Imperial (Inches).

## Sample Properties

The EBC colour scale allows for a dilution to be made when the colour is darker than the scale. The PFXi uses this dilution factor and multiplies the result accordingly.

The dilution factor is stored against the sample measurement and its value can be printed, it is good practice to keep this information as it allows other users to see how a measurement was made.

The Brix value is used solely for the determination of ICUMSA value.

Both the Dilution factor and the Brix value can either have a default fixed value or the value can be manually entered at the time a measurement is made.



Press or to move the highlight bar to **“Sample Properties”**.

Press to select.

## Dilution Factor

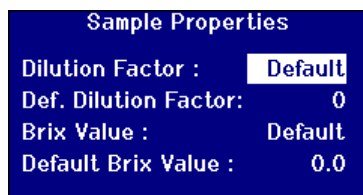

Press or to move the highlight bar to **“Dilution Factor”**.

Press or to scroll through the list of options.

Options are “Default” or “Manual”.

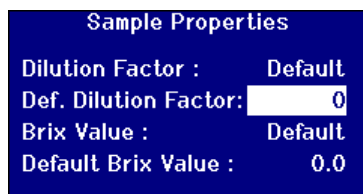

## Entering the default Dilution factor



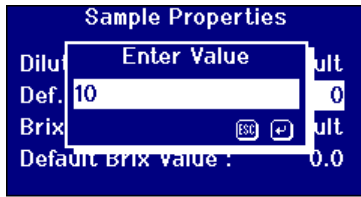

Press or to move the highlight bar to **“Def. Dilution Factor”**.



Press to change the value.



Use the numeric keys and the  to enter the value required. Press  to delete the last character entered if a mistake is made.

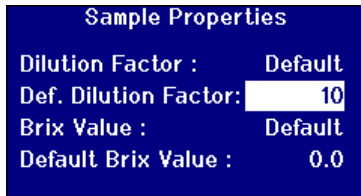

Press  to exit without changing the value or press  to accept the value and return to the previous screen.



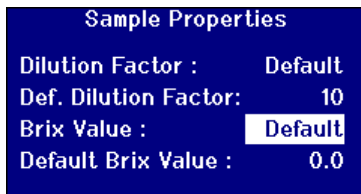

Press  or  to move the Highlight to the next item.

### Brix Value





Press  or  to move the highlight bar to **"Brix Value"**.

Press  or  to scroll through the list of options.

Options are "Default" or "Manual".

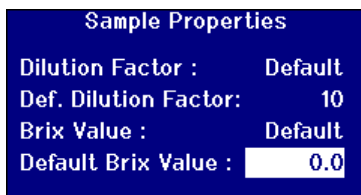

### Entering a default value for Brix



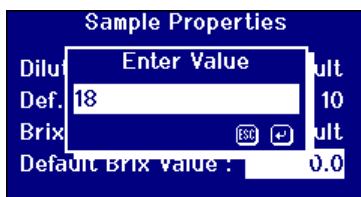

Press  or  to move the highlight bar to **"Default Brix Value"**.



Press  to change the value.

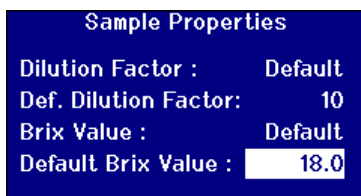

Use the numeric keys and the  to enter the value required. Press  to delete the last character entered if a mistake is made.

Press  to exit without changing the value or press  to accept the value and return to the previous screen.



Press  or  to move the highlight to the next item.



### Measurement Averaging



Press or to move the highlight bar to **“Measurement Averaging”**.

Press to select.

### Switch Measurement Averaging On/Off

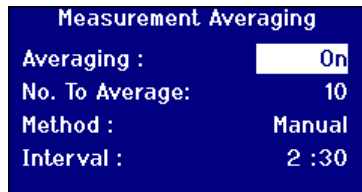

Press or to move the highlight bar to **“Averaging”**.

Press or to scroll through the list of options.

Options are “On” or “Off”.

### Setting the Number of Measurements to Average

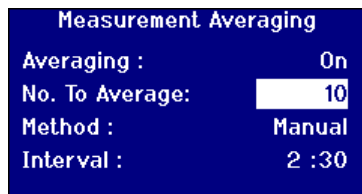

Press or to move the highlight bar to **“No. To Average”**.

Press to change the value.

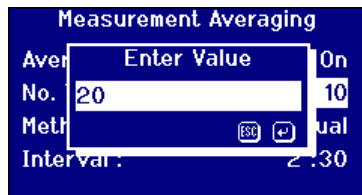

Use the numeric keys and the to enter the value required. Press to delete the last character entered if a mistake is made.

Press to exit without changing the value or press to accept the value and return to the previous screen.

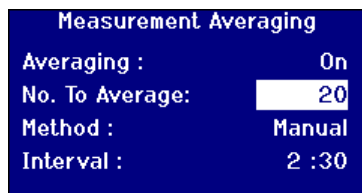

Press or to move the highlight to the next item.

### Selecting the Averaging Method

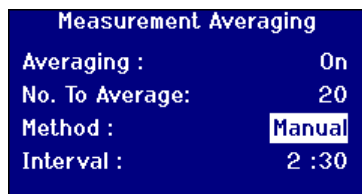

Press or to move the Highlight bar to **“Method”**.

Press or to scroll through the list of options.

Options are “Manual” or “Automatic”.

### Setting the Time Interval for Automatic Averaging

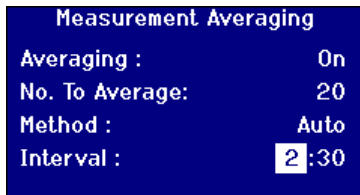

Press or to move the highlight bar to **“Interval”**.

The Format for the interval is Minutes: Seconds.

Press to change the value.

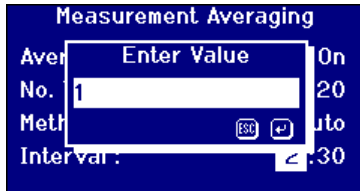

Use the numeric keys and the to enter the value required. Press to delete the last character entered if a mistake is made.

Press to exit without changing the value or press to accept the value and return to the previous screen.

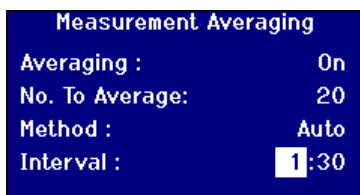

Press or to move the highlight to the next item.

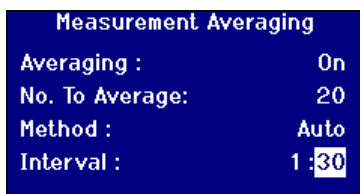

Press to change the value.

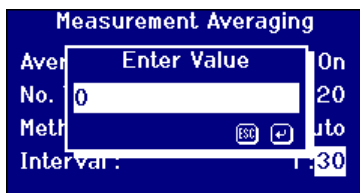

Use the numeric keys and the to enter the value required. Press to delete the last character entered if a mistake is made.

Press to exit without changing the value or press to accept the value and return to the previous screen.

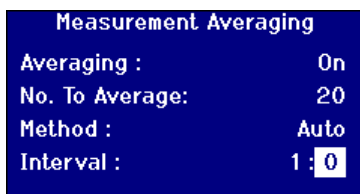

Press or to move the highlight to the next item.

## Measurement Logging



Press **MENU**

Press **▲** or **▼** to move the highlight bar to **"Measurement Options"**.

Press **↓** to select.

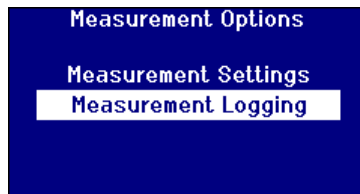

Press **▲** or **▼** to move the highlight bar to **"Measurement Logging"**.

Press **↓** to select.

### Switching Logging On/Off

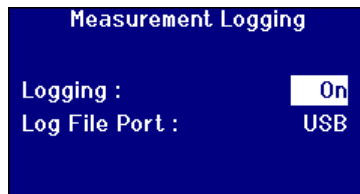

Press **▲** or **▼** to move the highlight bar to **"Logging"**.

Press **▶** or **◀** to scroll through the list of options.

Options are "On" or "Off".

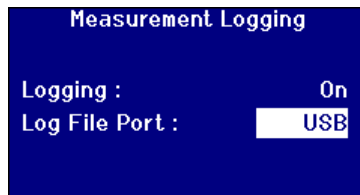

Press **▲** or **▼** to move the highlight bar to **"Log File Port"**.

Press **▶** or **◀** to scroll through the list of options.

Options are "Internal" or "RS232".

## Setting the Heater (only available on heated versions)



Press **MENU**

Press **▲** or **▼** to move the highlight bar to **"Heater"**.

Press **↓** to select.

### Switching the Heater On/Off

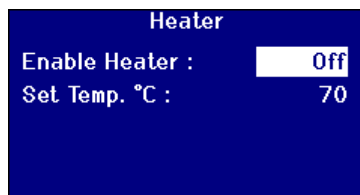

Press **▲** or **▼** to move the highlight bar to **"Enable Heater"**.



Press **▶** or **◀** to scroll through the list of options.

Options are "On" or "Off".

The Heater can be switched on/off from the Result screen by pressing **Func** then **2** to switch the heater off or **Func** then **3** to switch the heater on.

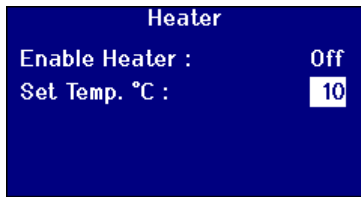

### Setting the Required Temperature



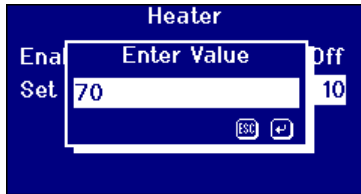

Press  or  to move the highlight bar to **"Set Temp. °C"**.



Press  to change the value.

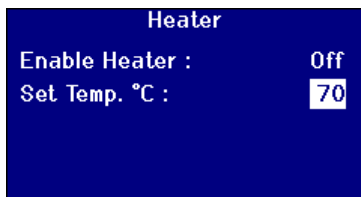

Use the numeric keys and the  to enter the value required. Press  to delete the last character entered if a mistake is made.

Press  to exit without changing the value or press  to accept the value and return to the previous screen.



Press  or  to move the Highlight to the next item.

## Selecting Colour Scales

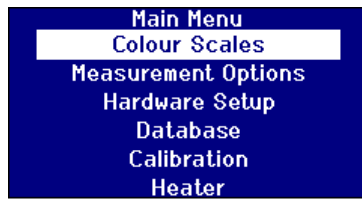

Press **MENU**

Press **▲** or **▼** to move the highlight bar to "**Colour Scales**".

Press **▣** to select.

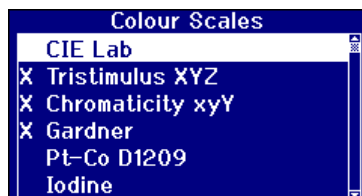

Press **▲** or **▼** to move the highlight bar to the colour scale required.

Press **▣** to select or deselect a colour scale, an "X" before the colour scale name indicates that the scale has been selected.

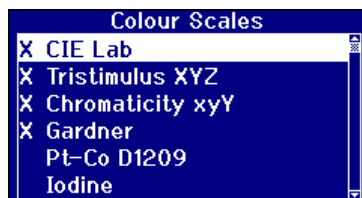

Press **▲** or **▼** to move the Highlight to the next item or

Press **Esc** to leave the menu.

## Unlocking a Colour Scale

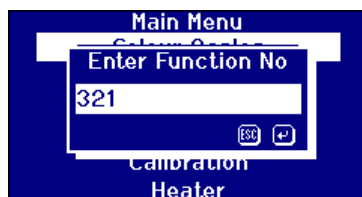

Press **Func** and Enter the function number 321.

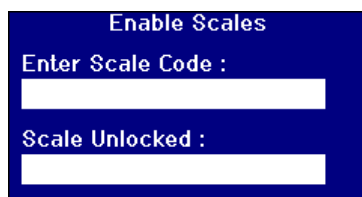

Enter the code provided to you and then press **▣**, the box marked "Scale Unlocked" will show the name of the colour scale that has been unlocked.

## Performing a Baseline Measurement

It is necessary to take a baseline measurement before carrying out sample measurements and at intervals during prolonged use. The baseline measurement calibrates the instrument on both dark and light values. **When performing a baseline measurement, ensure that the sample chamber is empty.**

This measurement should be repeated at least every 4 hours by pressing the **ZERO** key.



When the baseline measurement is completed, the instrument will go back to the screen that was displayed before **ZERO** was pressed.

Please note that in the following cases, the baseline should be carried out on a blank specified in the standard methods in a cell.

Scale	Cell	Substance for baselining
Acid Wash	Acid wash tube	Deionised water
ADMI (3 filter)	50mm cell	Deionised water
ASBC	10mm cell	Deionised water
Beta Carotene	10mm cell	Cyclohexane
EBC (430nm)	10mm cell	Deionised water
ICUMSA (in PFX195)	50mm cell	Distilled Water
ICUMSA (in PFX880,950,995)	100mm cell	Distilled Water
Klett	40mm cell	Distilled Water
Pt-Co (in PFX195)	50mm cell	Deionised Water

### Sample Preparation

Where the measurement is according to a standard test method (see table below), refer to the method for details of sample preparation. In general, samples should be clear and not turbid, as suspended matter can cause scattering of the light beam, resulting in low transmittance values which do not correspond with the sample colour.

Ensure that the end windows of the sample cell are clean and take care to handle cells only by the sides. Allow viscous samples time to settle, ensuring that air bubbles have dispersed and there is no movement in the sample.

When samples are measured at elevated temperatures, the cell should also be heated to prevent the temperature gradient from distorting the light beam. Stirring the sample in the cell prior to measurement can help to create an even temperature throughout the sample.

Colour Scale	References
ASTM Color	ASTM D 6045, ASTM D 1500
FAC Colour	AOCS Cc 13a-43
Gardner Color	ASTM D 1544, ASTM D 6166, AOCS Td 1a
Iodine Colour	DIN 6162
Klett Color	AOCS Dd 5-92
Platinum-Cobalt/ Hazen/APHA Colour	ASTM D 1209, AOCS Ea 9-65, AOCS Td 1b-64
Saybolt Color	ASTM D 6045, ASTM 156

## Taking a Measurement

After the baseline measurement is finished, the instrument is ready for use. **Position the sample cell at the right hand end of the sample chamber.** Close the sample chamber lid and press the **READ** key.

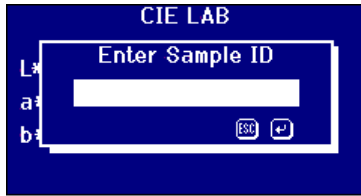

If Sample ID has been selected, the following screen will appear.

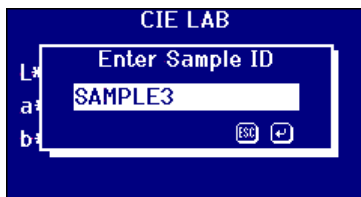

Use the Alpha numeric keys to enter the value required. To get to the letters you want you'll need to press the keypad one, two or three times. For example, to get the letter "C" you'll need to press the **2** three times.

Press **Del** to delete the last character entered if a mistake is made.

Press **Esc** to exit or Press **↵** to accept the value.

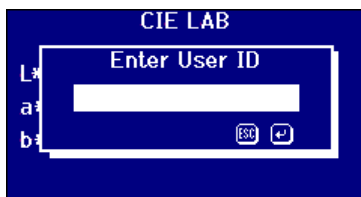

If User ID has been selected, the following screen will appear.

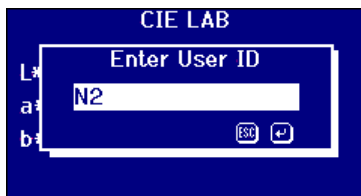

Use the Alpha numeric keys to enter the value required. To get to the letters you want you'll need to press the keypad one, two or three times. For example, to get the letter "C" you'll need to press the **2** three times.

Press **Del** to delete the last character entered if a mistake is made.

Press **Esc** to exit or Press **↵** to accept the value.



If an ICUMSA colour scale has been selected and the Brix value has been set to manual the following screen will appear.



Use the numeric keys to enter the value required. Press **Del** to delete the last character entered if a mistake is made.

Press **Esc** to exit or press **↵** to accept the value.





If the Dilution factor has been set to manual the following screen will appear.

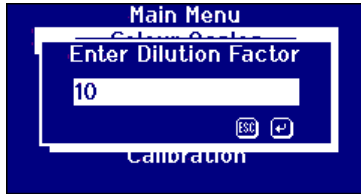

Use the numeric keys to enter the value required. Press **Del** to delete the last character entered if a mistake is made.

Press **Esc** to exit or press **OK** to accept the value.



The progress bar shows the status of the measurement. When the measurement has been completed, the screen will show the result.

## Displaying Results

### Spectral Information



Press **Up** or **Down** to change the wavelength value or press

**Left** or **Right** to scroll through the selected colour scales.

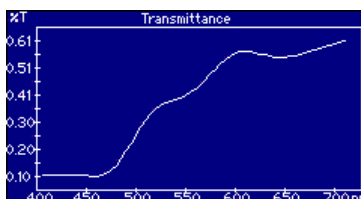
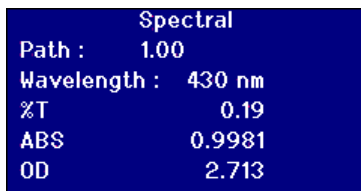

Press **F2** to switch the display between text and graphical display of the result.

### CIE Color Scales

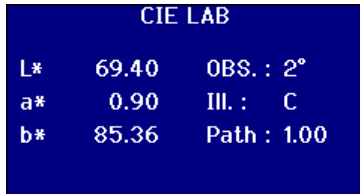

Use or to scroll through the selected colour scales or

press **F2** to switch the display between text and graphical display of the result.

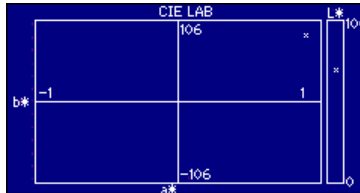

Use or to scroll through the selected colour scales or

press **F2** to switch the display between text and graphical display of the result.

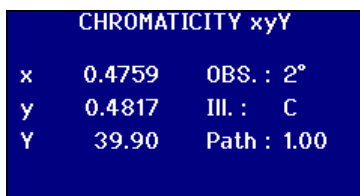

Use or to scroll through the selected colour scales or

press **F2** to switch the display between text and graphical display of the result.

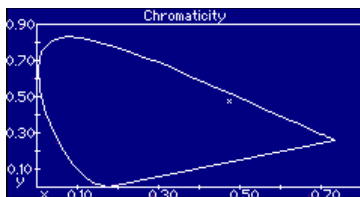

### Other Colour Scales

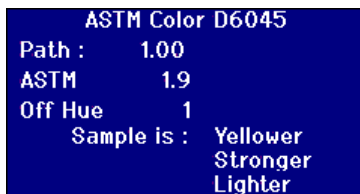

Use or to scroll through the selected colour scales or

press **F2** to switch the display between text and graphical display of the result.

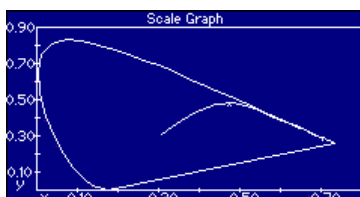

The Graph shows the line of the colour scale in the CIE xy Chromaticity diagram. The measured sample is shown as an "x".

## Printing Results

If "Measurement Logging" has been set to "ON" the results for the selected colour scales will be output to the port selected.

A serial printer can be connected to the RS232 port on the rear of the instrument. The printer should be set to match the output criteria of the instrument, the RS232 settings are:

Baudrate: 19200  
 Data Bits: 8  
 Stop Bits: 1  
 Parity: None  
 Handshaking: None

To print the result shown onscreen press **Func** then press **0**.

To print all the scales selected press **Func** then press **1**.

## Colour Difference Mode



At the Main Menu Press **Func**



To change between modes, enter **2** then Press Enter



Press **Esc** to return to the Results screen. A  $\Delta$  is now present in the top left hand corner of the screen to indicate that the instrument is now in compare mode.

CIE LAB			
OBS. :	2°	Path :	11.0
Ill. :	C		
L*	STD 0.00	SAMP 0.00	DIFF 0.00
a*	0.00	0.00	0.00
b*	0.00	0.00	0.00
		$\Delta E$	0.00

The results screen now shows the values for the standard and sample.

### Converting a Sample to a Standard



At the Main Menu Press **Func**



Enter **1** then Press Enter **↵**

CIE LAB			
OBS.:	2°	Path:	11.0
Ill.:	C		
L*	STD 81.46	SAMP 81.46	DIFF 0.00
a*	-32.94	-32.94	0.00
b*	92.44	92.44	0.00
		ΔE	0.00

The values for the sample will now have been copied over to the standard.

## Understanding Off Hue

When using a visual system to compare samples with glass standards, it is possible to see when the sample becomes too different in colour to make accurate colour comparisons. With automatic instruments, the nearest scale point is often displayed with no consideration of the colour difference between the sample and the colour scale. If the colours are not good matches, this approach increases the variability between visual and automatic methods.

Most colour scales such as Gardner, ASTM D1500 and Pt-Co are progressions of colour, most often from a pale yellow through to deep amber. The diagram below shows a representation of the Gardner scale.

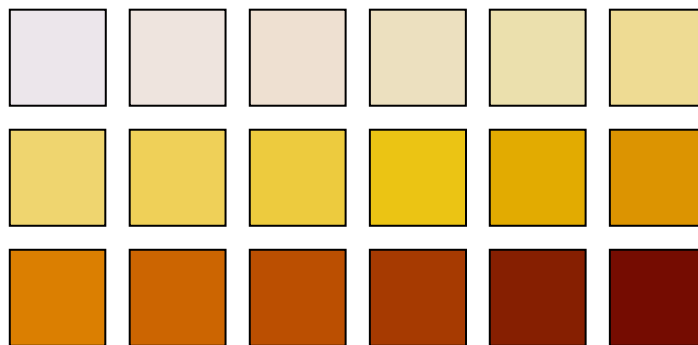

If the measured sample has a hue similar to that of one of the colour standards, then the user will find it easy to make a match in the visual system. This can be seen with the diagram below, where the different colour standards are shown on top and the sample to be measured below. It is quite apparent that the standard with the arrow above it is the best match.

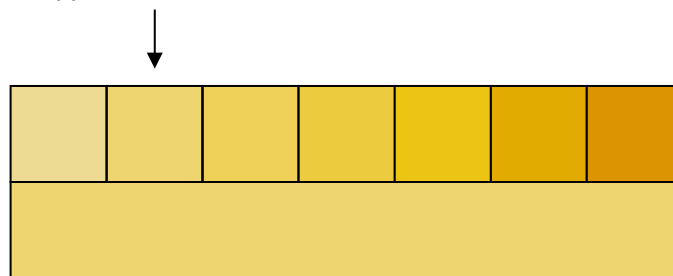

If the hue of the sample is dissimilar to the colour standards, making a match visually becomes far more subjective. In the diagram below, the nearest colour to the sample is shown by the arrow and it is this value that would be predicted by automatic instruments. Visually, because of the hue difference, the value selected might well be the next standard along to the right. The PFXi instrument would report this sample with an Off Hue factor of 5.

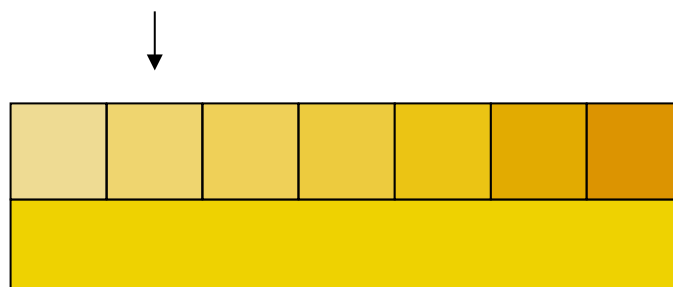

In the following example, the nearest colour is still the arrowed standard but Off Hue factor has been increased to 11. In this example one would expect a visual comparison to give the result as the 6<sup>th</sup> standard along.

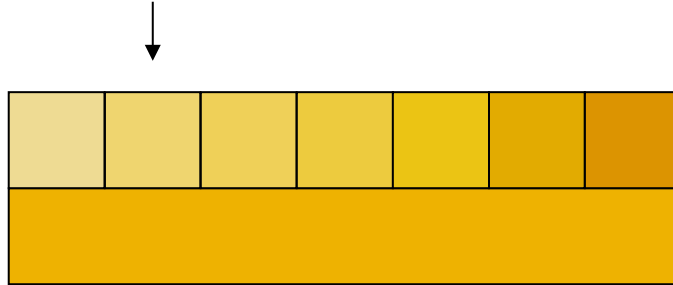

It might be expected that the example below would never be achieved. However, it must be considered as those coming into colour measurement with automatic instruments, who have never used the visual instruments, might not have a comprehension of the colours of that colour scale. Automatic instruments may well provide the answer as the arrowed standard, which has an Off Hue factor of 17. The result from a visual system would certainly be highly subjective and no two users would be likely to provide the same result.

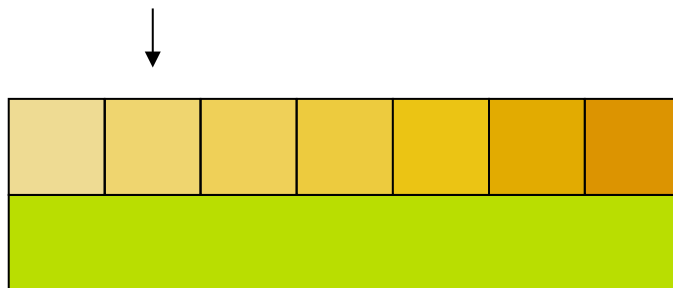

The PFXi instruments not only display the Off Hue factor but also a description of the colour difference such as redder and/or lighter.

## Database Functions

### Store the Current Measurement



Press **MENU**



Press  or  to move the Highlight bar to **"Database"**.

Press  to select.

---

---



Press  or  to move the Highlight bar to **"Store"**.

Press  to select.

---

---

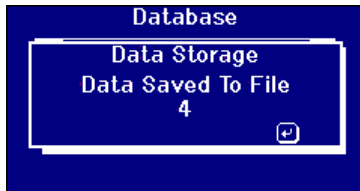

The software will show a confirmation screen to show that the Measurement has been stored OK.

Press  to exit.

### Retrieve a Measurement



Press **MENU**

Press **▲** or **▼** to move the Highlight bar to **"Database"**.

Press **↵** to select.



Press **▲** or **▼** to move the Highlight bar to **"Retrieve"**.

Press **↵** to select.

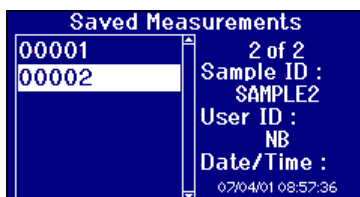

Press **▲** or **▼** to move the Highlight bar to select the saved measurement. The details of the measurement are shown on the right hand side of the display.

Press **↵** to select the highlighted measurement.

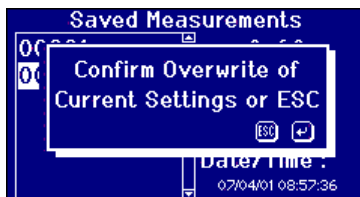

If the current instrument settings are different from that of the saved measurement, confirmation is required to change the settings to that of the saved measurement.

Press **Esc** to exit or press **↵** to accept.



The Software will show a confirmation screen to show that the Measurement has been retrieved OK.

Press **↵** to exit.

### Edit a Stored Measurement



Press **MENU**

Press **▲** or **▼** to move the Highlight bar to **"Database"**.

Press **↵** to select.



Press **▲** or **▼** to move the Highlight bar to **"Edit"**.

Press **↵** to select.



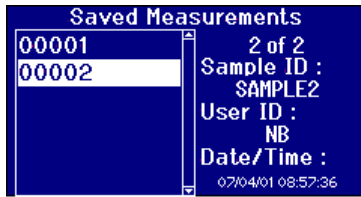

Press or to move the Highlight bar to select the saved measurement. The details of the measurement are shown on the right hand side of the display.

Press to select the highlighted measurement.

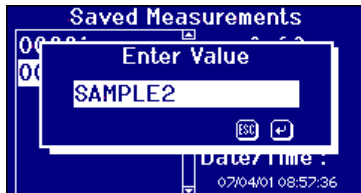

The Sample ID for the measurement is shown in the edit box.

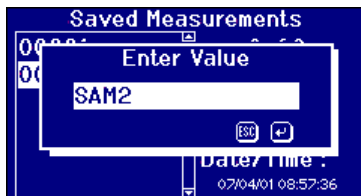

Use the Alpha numeric keys to enter the value required. To get to the letters you want you'll need to press the keypad one, two or three times. For example, to get the letter "C" you'll need to press the three times.

Press to delete the last character entered if a mistake is made.

Press to exit or press to accept the value.

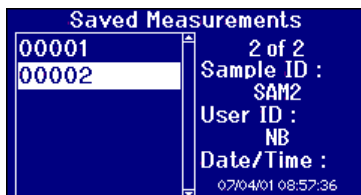

The new sample ID value for the measurement is shown on the right hand side of the display.

Press to exit.

## Remote Calibration

This allows the user to calibrate the instrument using a Calibration Pack they have purchased. The Calibration Pack will have been measured using the ISO17025 calibration facility at The Tintometer Limited. To use this feature the user needs to be able to connect to the Tintometer Limited Calibration Server, and to have previously registered their instrument. The Calibration Packs should always be used within 1 month of receipt.

When Remote Calibration is selected the instrument will open a communication channel with the Calibration Server located at The Tintometer Ltd. Once the channel has been opened, the Calibration Server will request the Calibration Pack code. The user enters the Calibration Pack code. This code is then sent to the Calibration Server. The Calibration Server validates that the pack has not been used before and that it is within its shelf life. Once confirmed, the Calibration Server sends back the Solution ID's for all the solutions within the Calibration Pack. The user is requested to place the Calibration Pack solutions into the sample chamber and press 'Read'. Once all the solutions have been measured, the Data is sent back to the Calibration Server. The Data is compared to the ISO 17025 calibration data for the solutions. If the data passes within tolerance, a certificate of calibration is emailed to the user. If the error was small the Calibration Server will calculate and send back correction factors to the instrument. The user is then asked if they would like to apply the correction factors. If the correction factors are applied, the measurements of the solutions are repeated to confirm the instrument is operating correctly..

If, at any point in the calibration process, a major error is found, the user is informed and the process stops. The user should then contact their local Service Centre.

### Calibration Procedure

If you have not already registered the instrument with The Tintometer Ltd, please go to Appendix 1, ***"Registering your Instrument"***



Press **MENU**

Press **▲** or **▼** to move the highlight bar to **"Calibration"**.

Press **↵** to select.

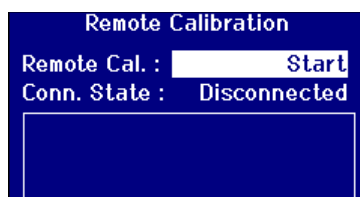

Press **▲** or **▼** to move the highlight bar to **"Remote Cal"**.

Press **↵** to start the calibration.

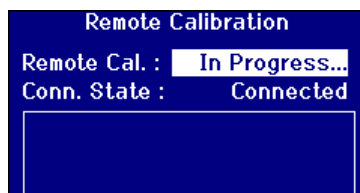

The Instrument will now contact the Calibration Server at The Tintometer Ltd. Once a connection has been established, the **"Conn. State"** will show "Connected".

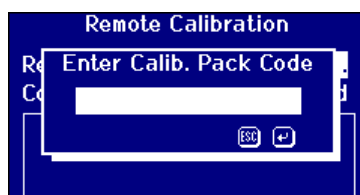

Use the numeric keys to enter the value required. Press **Del** to delete the last character entered if a mistake is made.

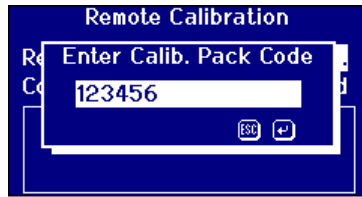

Press **Esc** to exit or press **Enter** to accept the value and return to the previous screen.

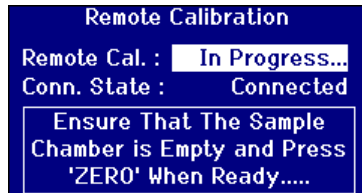

Follow the instructions shown on the display.

The First operation of the calibration is to perform a baseline measurement. Ensure that the sample chamber is empty and then press **ZERO**.



The progress of the baseline is shown on the progress bar in the display.

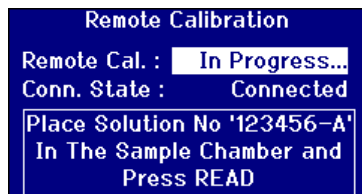

Once the baseline measurement has completed, the display will request a solution for measurement. The solution Number will depend on the pack code.

Pour the solution into the measurement cell and place the cell into the instrument; then press **READ**.



The progress of the measurement will be shown on the progress bar in the display.

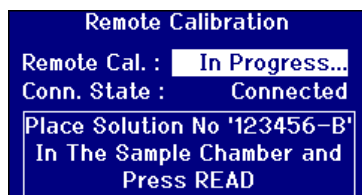

Each solution in the calibration pack will be requested in turn and the measurement operation should be performed for each solution. The used solution should be discarded after use and not returned to the bottle.



When all the solutions have been measured, the measured data is sent to the Calibration Server for verification.

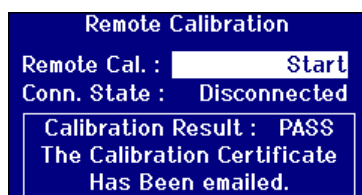

When the measurements have been verified, the Calibration Server will send a confirmation message back to the instrument. An email containing the calibration certificate will be sent to the email address registered on the calibration site.

If the verification should fail, the Calibration Server will send back information to the instrument display.

## Maintenance

### The Lamp

The expected lamp life is 600,000 measurements before failure. When replacing the lamp, always unplug the instrument from the power supply. Undo the two thumbscrews and remove the lamp block. Unscrew the lamp from the block and replace with the new lamp. **Do not touch the glass lens on the lamp, as fingerprints will impair its performance.** Replace the lamp block and tighten the thumbscrews.

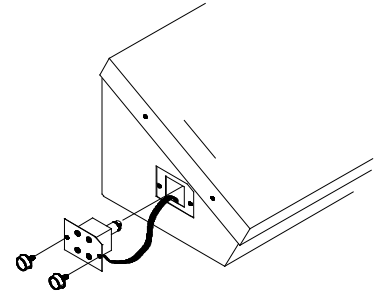

After the lamp has been changed,



Press **MENU**

Press **▲** or **▼** to move the Highlight bar to **“Hardware Setup”**.

Press **↵** to select.



Press **▲** or **▼** to move the Highlight bar to **“Instrument Settings”**.

Press **↵** to select.

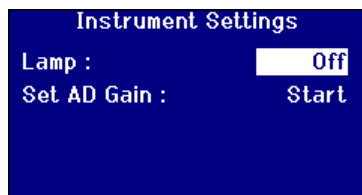

Press **▲** or **▼** to move the highlight bar to **“Lamp”**. The lamp can be switched on and off to test the lamp.

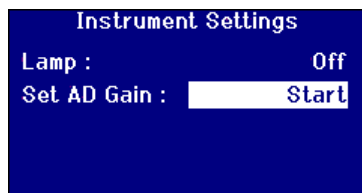

After the lamp has been changed, the gain settings of the instrument need to be set. Move the highlight bar to **“Set AD Gain”** and press **↵** to start the process.

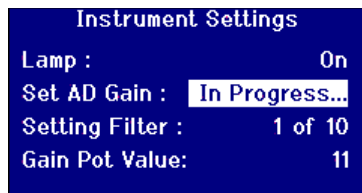

The process will take several minutes. The display will show the progress of the operation.

## Sample Chamber

The sample chamber can be removed for routine cleaning or replacement. To remove the sample chamber, open the sample chamber lid to its full extent. The sample chamber can then be lifted free from the instrument base as shown in the diagram. If a heater unit is fitted, disconnect the heater power cable and thermocouple leads from the connectors in the sample chamber area.

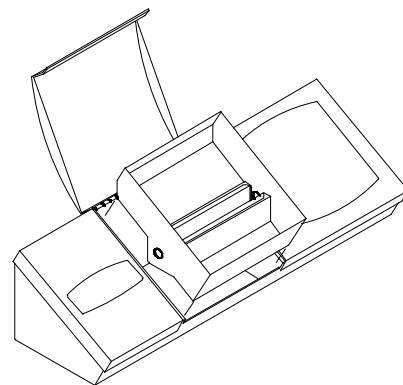

## Lovibond® Glass Cells

The Lovibond® PFXi series instruments use the W600 series of optical glass and borosilicate glass cells. The choice of cell path length depends on the instrument version and the colour scale being used. For versions equipped with the heater unit, it is recommended that borosilicate glass cells be used whenever hot samples are measured.

Path Length	W600/OG Series Fused Optical Glass		W600/B Series Fused Borosilicate Glass	
	Order Code	Type	Order Code	Type
2.5 mm	60 59 40	W600/OG/2.5		
5 mm	60 59 50	W600/OG/5		
10 mm	60 59 60	W600/OG/10	65 59 60	W600/B/10
15 mm	60 59 70	W600/OG/15		
20 mm	60 59 80	W600/OG/20		
25 mm	60 59 90	W600/OG/25	65 59 90	W600/B/25
33 mm	60 60 10	W600/OG/33	65 60 10	W600/B/33
40 mm	60 60 20	W600/OG/40	65 60 20	W600/B/40
50 mm	60 62 00	W600/OG/50	65 62 00	W600/B/50
100 mm	60 60 30	W600/OG/100	65 60 30	W600/B/100
1/16"	60 60 40	W600/OG/1/16"	65 60 40	W600/B/1/16"
1/8"	60 60 50	W600/OG/1/8"	65 60 50	W600/B/1/8"
1/4"	60 60 60	W600/OG/1/4"	65 60 60	W600/B/1/4"
1/2"	60 60 70	W600/OG/1/2"	65 60 70	W600/B/1/2"
1"	60 60 80	W600/OG/1"	65 60 80	W600/B/1"
2"	60 60 90	W600/OG/2"	65 60 90	W600/B/2"
3"	60 61 00	W600/OG/3"	65 61 00	W600/B/3"
4"	60 61 10	W600/OG/4"	65 61 10	W600/B/4"
5"	60 61 20	W600/OG/5"	65 61 20	W600/B/5"
5 1/4"	60 61 30	W600/OG/5 1/4"	65 61 30	W600/B/5 1/4"
6"	60 61 50	W600/OG/6"	65 61 50	W600/B/6"
1 mm Dark Sample Cell	13 28 20	W600/OG/10 with 9 mm spacer		

For further information on Lovibond® cells, please ask your supplier.

## Certified colour reference materials

Lovibond® certified colour reference materials are ideal for routine calibration of colour measuring instruments and verification of test data. They have full traceability to internationally recognised standards: ASTM Color, Gardner & Saybolt standards certified under UKAS to ISO 17025; AOCS-Tintometer®, Lovibond® RYBN Colour and Pt-Co Colour certified under ISO 9001 quality system. Each standard is supplied in a 500 ml bottle with an expiry date of guarantee of colour stability and full certification including MSDS. They are all classified as non-hazardous according to EU directives. The values indicated in the table are typical nominal values. Individual values may vary but these are always specified on the certificate of calibration supplied with each standard.

Colour Scale	Nominal Certified Value	Order Code	Accreditation
AOCS-Tintometer® Colour (AOCS Cc 13j-97, Cc 13b-45)	0.3R 2.0Y (5¼")	13 42 40	ISO 9001
	1.0R 9.0Y (5¼")	13 42 50	ISO 9001
	1.2R 12Y (5¼")	13 42 60	ISO 9001
	2.2R 22Y (5¼")	13 42 70	ISO 9001
	3.4R 28Y (5¼")	13 42 80	ISO 9001
ASTM Color	<0.5	13 42 90	UKAS
	1	13 40 00	UKAS
	3	13 40 10	UKAS
	5	13 40 20	UKAS
Gardner Color	2	13 42 00	UKAS
	5	13 42 10	UKAS
	8	13 42 20	UKAS
Lovibond® RYBN Colour (AOCS Cc 13j-97)	0.4R 1.9Y 0.1N (5¼")	13 40 80	ISO 9001
	1.0R 4.3Y 0.1N (5¼")	13 40 90	ISO 9001
	1.4R 7.3Y 0.2N (5¼")	13 41 00	ISO 9001
	1.6R 11.0Y 0.1N (5¼")	13 41 10	ISO 9001
	1.8R 14.0Y 0.3N (5¼")	13 41 20	ISO 9001
	2.5R 24.0Y 0.5N (5¼")	13 41 30	ISO 9001
	3.3R 33.0Y 0.3N (5¼")	13 42 30	ISO 9001
	Pt-Co/Hazen/APHA	5	13 41 40
10		13 41 50	ISO 9001
15		13 41 60	ISO 9001
30		13 41 70	ISO 9001
50		13 41 80	ISO 9001
100		13 41 90	ISO 9001
500		46 28 03	ISO 9001
Saybolt Color	-10	13 40 40	UKAS
	0	13 40 50	UKAS
	+12	13 40 60	UKAS
	+25	13 40 70	UKAS

## Factors Influencing Inter-Instrument Differences in Lovibond® Colour Measurements

A common query relates to inconsistencies in the Lovibond® Colour values obtained for an individual sample when using different instruments (for example, an automatic Tintometer® Colorimeter such as the PFX995 and a visual instrument such as the Tintometer® Colorimeter Model E or F, or two different visual instruments). There are many reasons why such inconsistencies can arise. We have attempted to provide below a detailed list of the main factors which influence inter-instrument differences that should help you to resolve these queries. These factors fall into four main categories:

- Poor maintenance of a visual instrument
- Comparison of different instrument versions
- Incorrect use of visual instrument
- Limitations and errors associated with automatic measurement

### Poor Maintenance of a Visual Instrument

The Tintometer® Colorimeter Model F or E is a precision optical instrument and any discoloration of the white surfaces or dirt on the various optical components will affect the nature and balance of illumination within the instrument and result in false readings. As a result, for consistency and accuracy in colour measurement, the Tintometer® Colorimeter should be kept as clean as possible and the whiteness of the sample chamber and the white reference maintained. Particular attention should be given to the following areas:

**Dirt and grease on the glass filters and racks.** These can be cleaned with a soft cloth or washed gently with warm soapy water.

**Dust and dirt which gathers in the optical viewing system and can settle on the lens and correction filter.** If dirty the optical viewing system can be dismantled and the components cleaned with a suitable soft cloth. Be sure to reassemble correctly (see Tintometer® Colorimeter manual).

**Discoloration of the white reference.** Periodic replacement is necessary to maintain accuracy of measurement.

**Light source discoloration.** In the Tintometer® Model E and earlier models the tungsten bulbs will discolour with age so that the instrument's illumination is no longer standardised. As a result, the bulbs should be changed periodically.

**Discoloration and spillage in the white light sample chamber.** It is important to remove any spillage immediately and clean the chamber area.

Dirt on the bulb diffuser plates reducing the amount of illumination to the sample. These should be cleaned or replaced if dirty.

### Comparison of Different Instrument Versions

Users often assume that there is only one version of the Tintometer® Model E and Model F Colorimeters; in fact, these instruments have for some time been supplied in slightly varying formats to meet the requirements of national and international standard test methods which specify use of the Tintometer®. In particular, BS 684 Section 1.14, ISO/FDIS 15305 and AOCS Cc13e-92, all standard test methods for the determination of Lovibond® colour of animal and vegetable fats and oils, specify the use of the Model F (BS 684) (previously the Model E version AF905). These instruments include racks, which are fitted with colourless glass compensating slides in the sample field and a black sheath to prevent light entering the sides of the sample cell; they will give different readings to the standard Tintometer® Colorimeter versions and to automatic Lovibond® instruments.

#### Incorrect Use of Visual Instruments

**Incorrect use of neutral racks.** The two neutral racks included with the Tintometer® Colorimeter should be used to dull the sample so that the brightness in sample field and the brightness in the comparison field are comparable. Many visual instrument users fail to use neutral glasses; the result will be a lighter colour measurement to compensate for brightness in the sample field.

**Inappropriate choice of path length.** The optical path length of the cell used should be related to the colour intensity of the sample. As a guide, it is advisable to restrict the colour intensity of the sample to less than a total of 30 - 40 Lovibond® units. Using a shorter path length cell can reduce colour intensity.

**Subjectivity of visual measurement.** Visual measurements are influenced by the discriminatory power of operators, their interpretation of a colour match and physiological factors such as age, eye fatigue and colour vision.

#### Limitations and Errors Associated with Automatic Measurement

**Use with samples which are turbid or crystalline.** This will affect colour measurement since turbidity prevents light being transmitted through the sample.

**Lack of care in sample cell cleaning and sample preparation.** Any contamination, uneven mixing or a temperature gradient might distort the light transmitted through the sample and affect measurements.



## Appendix 1

### The procedure for upgrading the PFXi firmware

Connect the PFXi to the source computer (laptop or PC) via USB.

Switch on the PFXi whilst holding down the 'F1' on the instrument. A dialog will appear on the LCD screen with the text 'Enter Function No'

Enter '8192' and press enter  on the instrument keypad. The 'Firmware Upgrade' screen will appear with the message 'Waiting For Host....'

Start the PFXi Flash loader software on the PC :

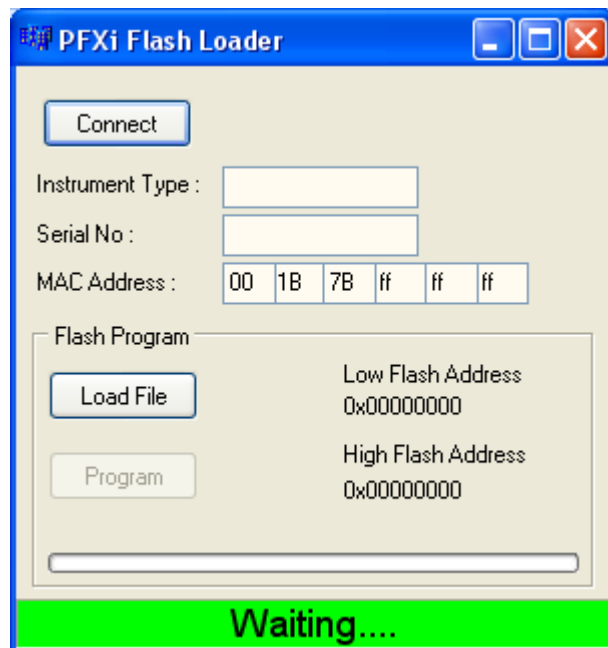

The green status bar indicates that the software is successfully communication with the instrument.

Click on the 'Connect' button and confirm the instrument type and serial number are correct.

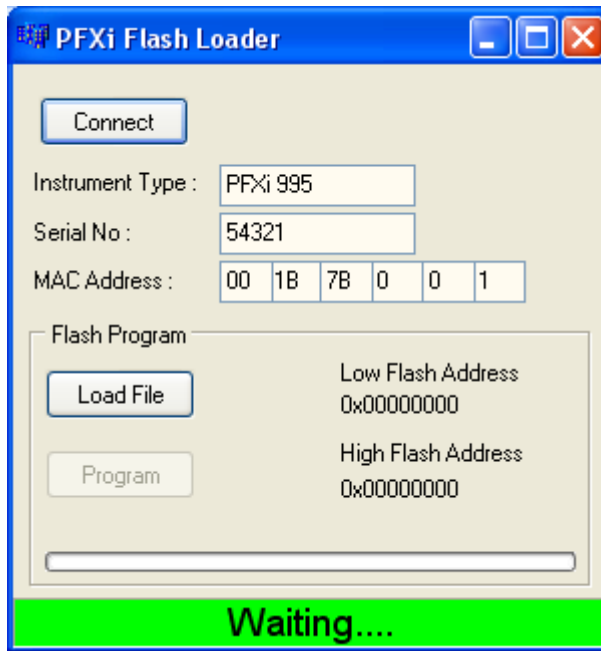

Click on the 'Load File' button and navigate to the new flash file ("PFXi\_100xx.flash"). The file will take a few seconds to load. When the file has loaded correctly, the 'Program' button will be enabled and the 'high' address of the firmware displayed (this is for information only):

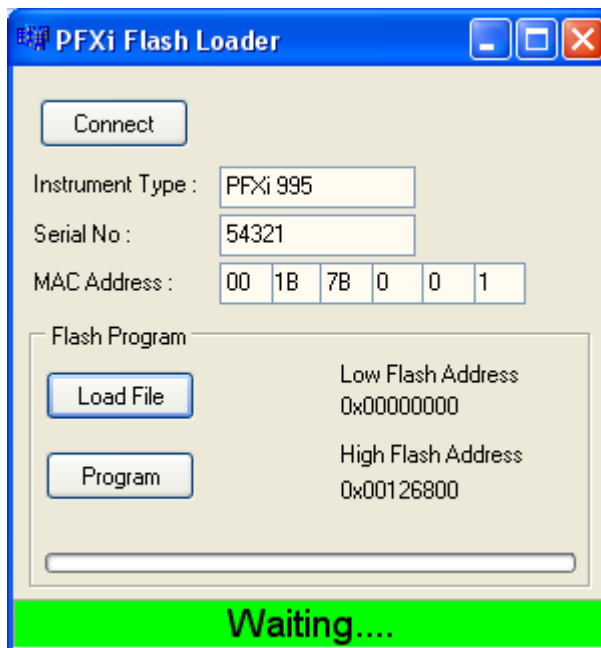

Click on the 'Program' button. The new firmware is then downloaded and programmed into the instrument.

**NOTE:**

**DO NOT** switch off or press any buttons on the instrument or the Flash Loader software until programming is complete. Failure to do so may render the instrument inoperable.

The Flash Loader software will indicate progress and instrument state during programming:

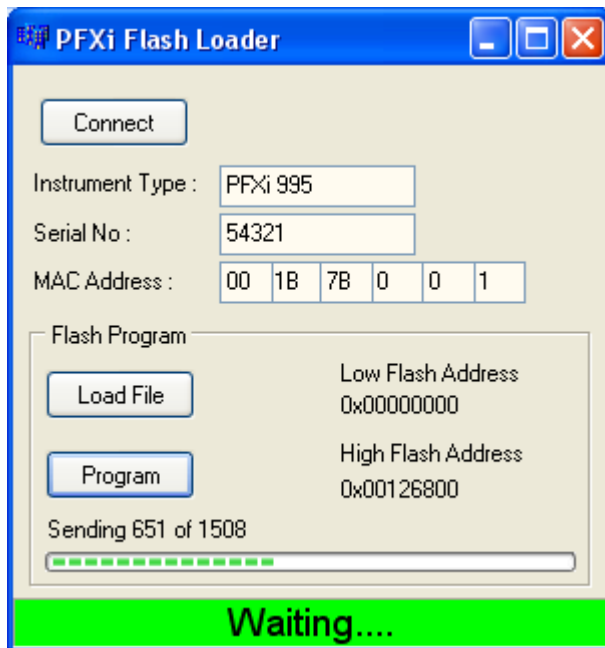

When programming is complete, the LCD screen will display 'Restart Instrument Update Successful' – Turn off the instrument power and restart. Confirm that the software version is correct on the instrument splash screen (it should match the version part of filename).

## Appendix 2

### Registering your Instrument

To register your instrument, go to <https://www.lovibond.com/en/Colour-Measurement> and Support and Service. Then select Instrument registration.

To register for the first time, select register.

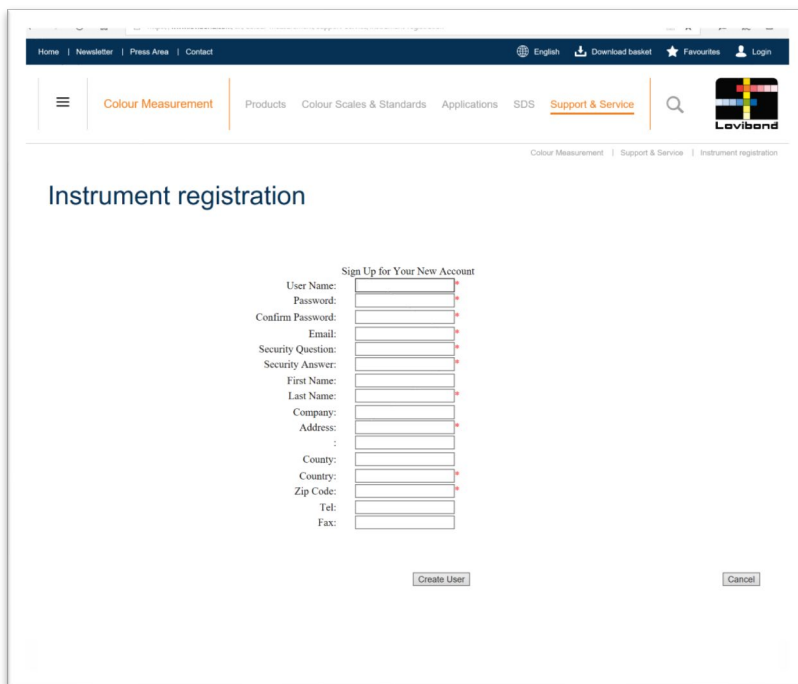
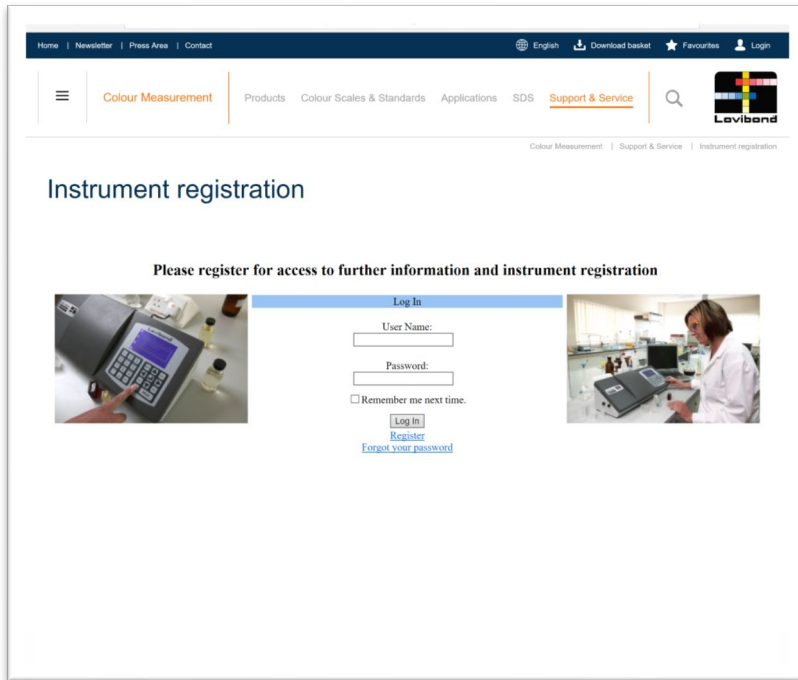

Fill in the required information. Any fields with a red “\*” by the side are required and must be filled in. If, as in the example above, the two password fields do not match, a red warning will appear at the bottom of the page.

Once all the fields have been filled with the required data, Click “Create User”.

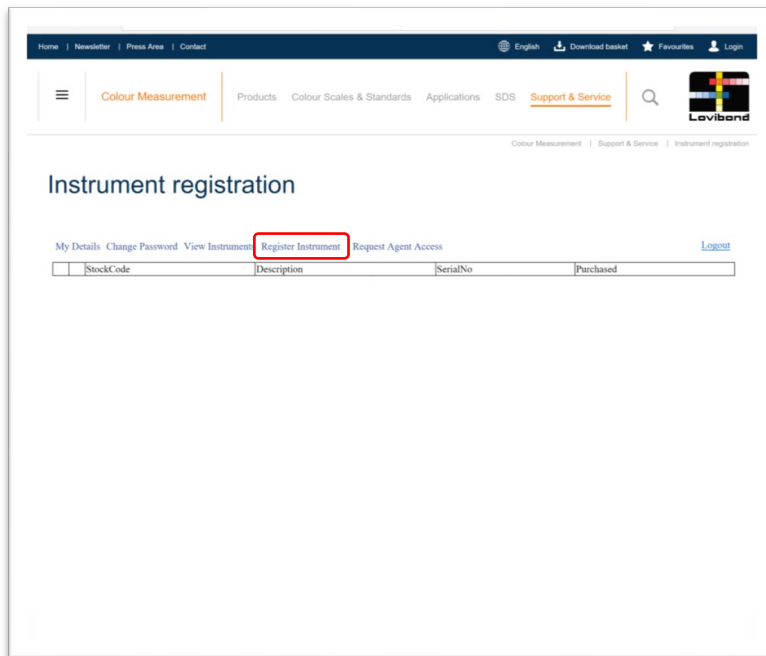

Click on “Register Instrument”

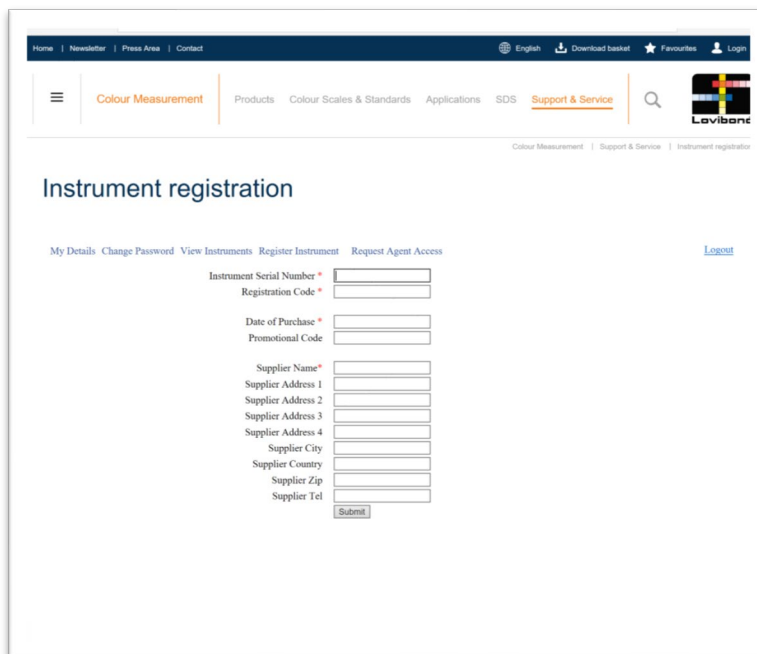

Information about the instrument can now be entered. The serial number of the instrument can be found on the label at the rear of the instrument. The registration code can be found on the Certificate of Conformity for the instrument.

Please fill in the details of the supplier of the instrument. This allows The Tintometer Ltd to inform them of any issues.

At the end of the process, a confirmation of registration is provided.

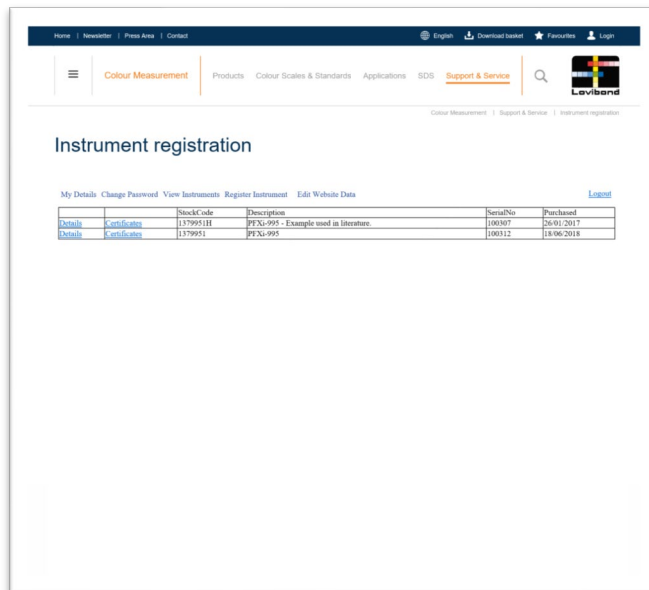

The instrument is now registered.

By selecting an instrument, it is possible to view its registration code. This can be done for each instrument that has been registered.